

# ***Class-E Audio Modulated Tesla Coil***

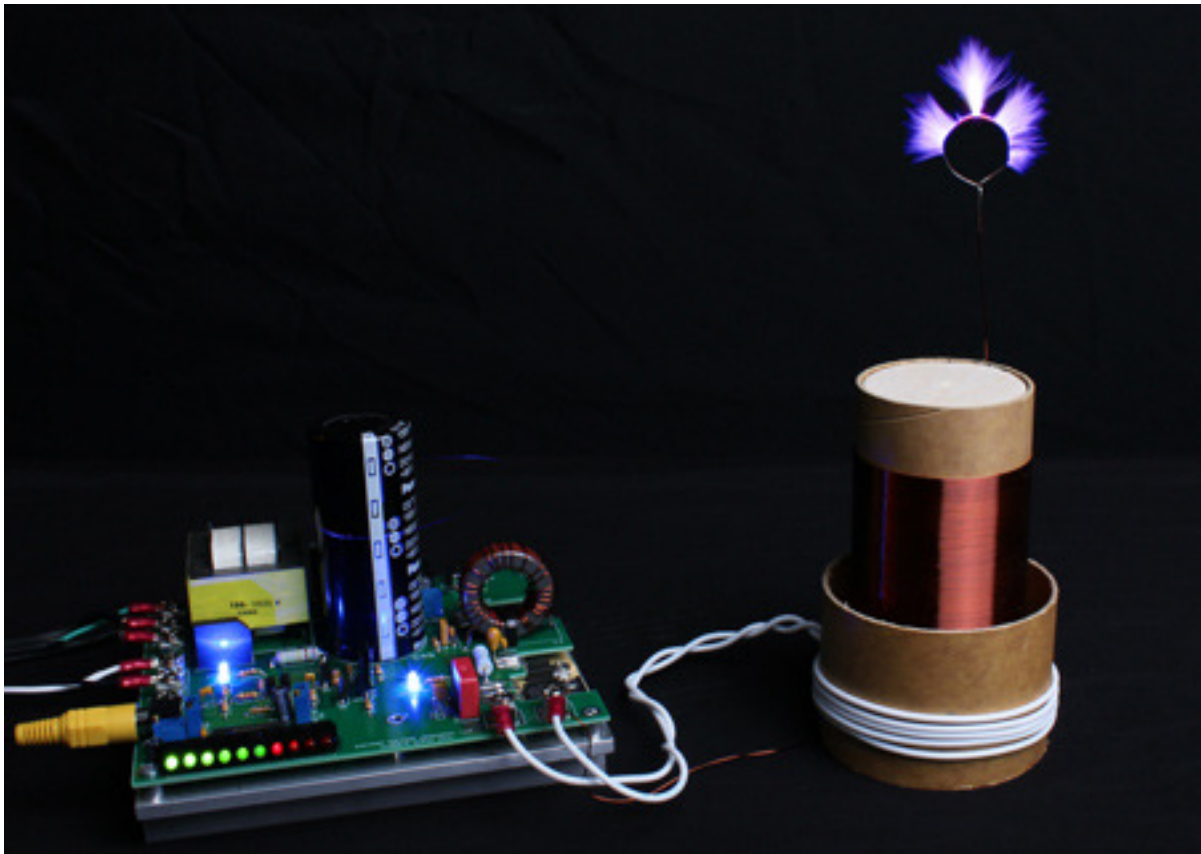

## ***Instruction Manual***

**Eastern Voltage Research, LLC**



## **BOARD REVISION C**

**This manual only applies to the new Revision C PCB boards. These boards can be identified by their red silkscreen color as well as the marking SC2076 REV C which is located underneath the location for T41 on the upper right of the PCB board.**

**If you have either a REV – and REV A PCB board, please use the REV 3 manual located on the website.**

**If you have a REV B PCB board, please use the REV C manual located on the website.**



## **AGE DISCLAIMER**

**THIS KIT IS AN ADVANCED, HIGH POWER SOLID STATE POWER DEVICE. IT IS INTENDED FOR USE FOR INDIVIDUALS OVER 18 YEARS OF AGE WITH THE PROPER KNOWLEDGE AND EXPERIENCE, AS WELL AS FAMILIARITY WITH LINE VOLTAGE POWER CIRCUITS.**

**BY BUILDING, USING, OR OPERATING THIS KIT, YOU ACKNOWLEDGE THAT YOU ARE OVER 18 YEARS OF AGE, AND THAT YOU HAVE THOROUGHLY READ THROUGH THE SAFETY INFORMATION PRESENTED IN THIS MANUAL.**

**THIS KIT SHALL NOT BE USED AT ANY TIME BY INDIVIDUALS UNDER 18 YEARS OF AGE.**



## **SAFETY AND EQUIPMENT HAZARDS**

**PLEASE BE SURE TO READ AND UNDERSTAND ALL SAFETY AND EQUIPMENT RELATED HAZARDS AND WARNINGS BEFORE BUILDING AND OPERATING YOUR KIT.**

**THE PURPOSE OF THESE WARNINGS IS NOT TO SCARE YOU, BUT TO KEEP YOU WELL INFORMED TO WHAT HAZARDS MAY APPLY FOR YOUR PARTICULAR KIT.**



## **PACEMAKER WARNING**

**THIS DEVICE WHEN CONNECTED TO A RESONATOR WILL PRODUCE ELECTRICAL AND MAGNETIC FIELDS. EXPOSURE TO THIS FIELD SHOULD BE LIMITED. DO NOT USE THIS KIT IF YOU HAVE AN IMPLANTED PACEMAKER OR OTHER BIOMEDICAL DEVICE!**



## **VARIAC WARNING**

**DO NOT USE A VARIAC WITH THIS PRODUCT. THIS PRODUCT REQUIRES POWER THROUGH AN ISOLATED TRANSFORMER (SUCH AS THE ONES PROVIDED IN THE KITS). A VARIAC IS NOT ISOLATED AND USING A VARIAC WITH THIS PRODUCT WILL CAUSE A SHORT CIRCUIT TO OCCUR WHICH WILL RESULT IN PERMANENT DAMAGE TO THE CIRCUITS.**



### **ELECTRICAL HAZARD**

**This circuit utilizes dangerous line voltages up to 115VAC. Failure to handle this circuit in a safe manner may result in serious injury or death!**



### **POWER SEMICONDUCTOR HAZARD**

**This is a solid state power device. Components may fail explosively at any time and eject high velocity projectiles. EYE PROTECTION IS REQUIRED AT ALL TIMES!**



### **ELECTROMAGNETIC FIELD HAZARD**

**This device when connected to a resonator will produce strong electric and magnetic fields. Exposure to this field should be limited. DO NOT USE THIS KIT IF YOU HAVE AN IMPLANTED BIOMEDICAL DEVICE!**



## **FIRE HAZARD**

**Due to high power dissipations of the the various semiconductors devices attached to the heatsink, the heatsink may become extremely hot, especially during periods of continuous operation. Please ensure the heatsink is not installed on or near any flammable material and that a cooling fan is ALWAYS used during operation.**



## **PORTABLE AUDIO SOURCE WARNING**

**The use of portable audio devices, MP3 players, IPODs, iPhones, etc... is NOT RECOMMENDED. The RF fields and noise generated by the coil can potentially damage these types of devices.**

## **SAFETY GUIDELINES FOR LINE POWERED EQUIPMENT**

The electronic kit you purchased utilizes line voltages (115VAC) and also contains circuitry that produces output voltages in excess of 400VDC. Normally, consumer electronics equipment are safely enclosed to prevent accidental contact. However, the kit you have purchased does not come with an enclosure, and must be handled and operated with this in mind. Voltages exceeding 35V pose a safety hazard and depending on overall conditions and your general state of health, voltage and current levels have the ability to serious harm or even kill.

The following guidelines are to protect you from potentially lethal electrical shock hazards as well as the equipment from accidental damage.

It is also important to note that the danger isn't limited to only your body providing a conductive path, namely your heart. Any involuntary muscle contractions caused by an electrical shock, while perhaps harmless in themselves, may cause the person to be injured by falling, hitting a body part on something sharp, etc....

The purpose of these set of guidelines is not to frighten you, but rather make you aware of the appropriate precautions needed to safely build and operate this electronics kit.

- Perhaps, the number one rule – Don't work alone! If something does happen, it is extremely important to have someone nearby to render assistance or to call for help.
- When working on energized equipment (namely those that are line powered), always keep one hand in your pocket. This ensures there is not a complete electrical path through your heart providing you accidentally make contact with live voltage.
- Wear footwear with non-conductive (rubber) soles. Do NOT work on line powered or high voltage equipment in barefeet.
- Always wear eye protection. Power semiconductor devices, and capacitors do have the potential to explode unexpectedly and project sharp fragments across the room.
- Always work in a clean, open area. Avoid working in cluttered spaces, especially if there are grounded objects nearby that could complete a circuit path in the event you make accidental contact with live voltage.
- Avoid wearing any kind of jewelry or other articles that could accidentally contact circuitry.
- Never operate your PC boards on top of conductive tables, or other conductive objects. PC boards should ALWAYS be supported by the provided stand-offs or placed on top of a non-conductive tabletop or other material.
- ALWAYS allow proper time for any large electrolytic or other high voltage capacitors to discharge after removing power prior to working or touching any circuit. ALWAYS use a multimeter to measure the voltage across large capacitors after power is disconnect to ensure the voltage has properly bled off.
- Use an isolation transformer if there is any chance of contacting line powered circuitry. A Variac is NOT an isolation transformer!
- Finally, if your kit involves a Tesla Coil – NEVER touch or attempt to draw an arc with an object from the output of a Tesla Coil. The output of a Tesla Coil poses not only an electrical hazard, but also a burn hazard. The output from even the smallest solid state Tesla Coil can cause serious burns. Always operate the Tesla Coil at a safe distance.

## **SAFETY GUIDELINES - SEMICONDUCTOR POWER DEVICES**

- Always wear eye protection. Power semiconductor devices, and capacitors do have the potential to explode unexpectedly and project sharp fragments across the room.
- Power semiconductors may be extremely hot. NEVER touch any semiconductors during operation or after use. Always allow proper time for components to cool down prior to handling them.

## **SAFETY GUIDELINES – HIGH TEMPERATURE COMPONENTS**

- Power semiconductors may be extremely hot. NEVER touch any semiconductors during operation or after use. Always allow proper time for components to cool down prior to handling them.
- The extruded aluminum heatsink will be extremely hot during and after use until it cools down to ambient temperature. NEVER place the heatsink on any material that is flammable such as wood, plastic, or paper. It is preferable to place the extruded aluminum heatsink onto a metal plate.
- NEVER operate the device without the use of a cooling fan. If you are using an extruded aluminum heatsink, be sure to blow fan parallel to the cooling fins of the heatsink to maximize the cooling effects of the fan. Always allow the cooling fan to continue running, even after power is removed, until the heatsink and board components are properly “cooled” down.

## **SAFETY GUIDELINES – ELECTROMAGNETIC FIELD OUTPUT**



**DO NOT USE THIS KIT if you have an implanted biomedical device such as a pacemaker!**

- Electromagnetic fields are produced when the Tesla coil is operating. Ensure that you and others are always at least five feet away from the devices during operation (small kits), and farther away with some of the larger kits such as the miniBrute Tesla Coil kit.
- Avoid contact with metallic objects. This is mostly important for the smaller CW based Tesla coils such as the SSTC 1.0 or Class-E Audio Modulated Tesla Coil. What happens is that the electromagnetic fields cause charge to build up on your person and any contact with something metallic will initiate a potential RF burn to occur. The burns are on the magnitude of an

electrostatic shock – they are rarely harmful, but they can surprise you and give you a small instant of localized pain – again similar in receiving a electrostatic shock. Maintaining at least five feet away from the Tesla coil will prevent his from occurring.

- DO NOT use this kit if you have an implanted biomedical device.

## Introduction to the Class-E Audio Modulated Tesla Coil

Thank you for purchasing the Class-E Audio Modulated Tesla Coil Kit. The Class-E Audio Modulated Tesla Coil kit produces a 1-2" output arc that can be audio modulated via a variety of audio sources, such as a CD or DVD player, and produce sound through the power modulation of the actual high voltage. The primary output stage of the circuit is a single-MOSFET Class-E switching stage which operates at 4MHz providing a nearly silent output arc capable of high quality audio reproduction.

Notice to Beginners: If you are first time kit builder, you may find this instruction manual easier to understand than expected. Each component in this kit has an individual check box, while a detailed description of each component is provided as well. If you follow each step in the instruction manual in order, and practice good soldering and kit building skills, the kit is next to fail-safe.



**Please read this manual in its entirety before building, testing, or operating your kit!**

## Circuit Description

The Class-E Audio Modulated Tesla Coil circuit is comprised of two major subcircuits; the Audio Drive Stage, and the Class-E Power Stage. Each of these circuits gets power from two simple linear power supply circuits. The first being comprised of 24VAC control transformer T41, rectifiers CR41 and CR42, and 12V linear regulator U2. This circuit provides the 12V housekeeping circuitry necessary to power all the drive circuitry and active components. The second power supply circuit is comprised of power transformer T42, bridge rectifier BR41, and DC filter capacitor, C45 (or C17 and C18). This circuit produces the unregulated DC voltage (typically 70-100VDC) which is used to provide the drain voltage to the Class-E Power Stage.

The Audio Drive Stage is a linear modulator circuit, using Q8 as the linear pass element. First, MOSFET Q8 is biased to approximately 80-85% of the drain voltage by using potentiometer R10. This bias voltage level is the quiescent operating voltage that the Class-E Power Stage will operate at with no audio applied. The modulator itself is comprised of a large number of discrete components, i.e. Q1-Q7, which act as a high voltage preamplifier. This preamplifier circuit takes the low-level input audio and converts it to a high voltage audio signal that is necessary to drive, or modulate, Q8. The audio modulated drain voltage is then connected to the Class-E Power Stage where its modulation of the high voltage arc creates the audio soundwaves you hear. Potentiometer R2 is simply an input level adjust, and potentiometer R16 sets the output gain of the preamplifier circuit.

The Class-E Power Stage is comprised of a 4MHz oscillator, high current gate driver circuit U1, switching MOSFET Q12, and tuning capacitors C10 and C12. First, a 4MHz square wave signal is produced by clock oscillator, XTAL1. The output of this oscillator then drives U1 which is a high-current, high frequency gate driver which produces a +12V output signal required to drive switching MOSFET Q12. Capacitors C10, C12 are extremely important in that their values are specially chosen to allow for proper tuned operation of the Class-E switching stage. Class-E switching theory is beyond the context of this document, but there are numerous sources on the internet that discuss this topic in great detail. I invite you to use your internet search engine of choice and explore the subject in more detail.

Finally, the output of the Class-E switching stage is driven directly into the primary, L101, of the Tesla resonator where it in turn produces high voltage at the secondary, L102.

## Kit Building Tips

A good soldering technique is key! Let your soldering iron tip gently heat both the wires and pads simultaneously. Apply solder to the wire and the pad when the pad is hot enough to melt the solder. The finished joint should appear like a small shiny drop of water on paper, somewhat soaked in. If the pads have not heated up sufficiently, melted solder (heated only by the soldering iron itself) will form a cold solder joint and will not conduct properly. These cold joints appear as dull beads of solder, and can be easily fixed by applying additional heat to the pad and wire. All components, unless otherwise noted, should be mounted on the top side of the board. This is the side with the silkscreen printing.

When installing components, the component is placed flat to the board and the leads are bent on the backside of the board to prevent the part from falling out before soldering. The part is then soldered securely to the board, and the remaining lead length is clipped off. It is also extremely important to place the components as close to the board as possible. This is necessary for proper operation over the wide frequency range of the various kits we provide. Also be sure that component lead lengths are always as short as possible. This will avoid adding any stray capacitances or inductances that can be detrimental to circuit operation.

An alternative approach (which is actually the one I use) is to install the component into the board and then apply a piece of masking tape on the topside to hold the component in place temporarily. The leads on the backside of the board are then trimmed leaving about 0.10" lead protruding through the backside of the board, and then soldered from the backside. You can then remove the masking tape, and finally apply a small amount of solder on the top to complete the joint on both sides. This is shown in the figure below.

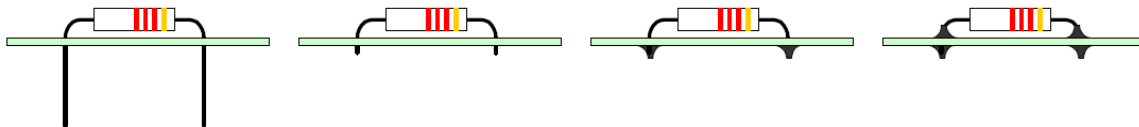

**Class-E Audio Modulated Tesla Coil Parts List****RESISTORS**

- 3 10k Resistor (brown-black-orange), R1,R6,R18
- 1 330k Resistor (orange-orange-yellow), R3
- 1 390k Resistor (orange-white-yellow), R4
- 4 2.2k Resistor (red-red-red), R5,R8,R12,R15
- 1 1.8k Resistor (brown-gray-red), R7
- 1 100k Resistor (brown-black-yellow), R9
- 1 68k, 1/2W Resistor (blue-gray-orange), R11
- 2 150 ohm Resistor (brown-green-brown), R13,R14
- 1 1k Resistor (brown-black-red), R17
- 1 220 ohm Resistor (red-red-brown), R19
- 1 1.6 ohm Resistor, 2W (brown-blue-gold)
- 1 1.5k Resistor (brown-green-red), R41
- 1 820 ohm Resistor (gray-red-brown), R42
- 1 120k, 2W Resistor (brown-red-yellow), R44
- 1 634 ohm Resistor (blue-orange-yellow-black-brown), R43
- 3 10k Potentiometer, R2,R16,R45
- 1 100k Potentiometer, R10
- 1 200k Resistor (red-black-yellow), R21

**CAPACITORS**

- 6 0.1uF Ceramic Capacitor, C5,C7,C9,C42,C44,C46
- 2 0.47uF Ceramic Capacitor, C1,C4
- 1 68pF Ceramic Capacitor, C2
- 1 22uF Electrolytic Capacitor, C3
- 3 10uF Electrolytic Capacitor, C6,C43,C47
- 1 560pF, 200V-500V Ceramic Capacitor, C10
- 1 1uF Ceramic Capacitor, C8
- 1 4.7nF, 630V Polypropylene Capacitor, C12
- 1 10uF, 35V Tantalum Capacitor, C13
- 1 2200uF - 4700uF Electrolytic Capacitor, C41
- 1 OPTION 1: (1) 8200uF-10000uF, 100V Electrolytic Capacitor, C45
- 2 OPTION 2: (2) 4700uF, 100V Electrolytic Capacitors, C17, C18

Note: Your kit will be supplied with either OPTION 1 or OPTION 2 depending on capacitor availability.

**DIODES**

- 1 Bridge Rectifier (marked KBL04, KBL06, or KBL08), BR41
- 1 1N4733 Zener Diode (marked 1N4733), VR1
- 3 1N4002 Diode (marked 1N4002), CR41, CR42, CR43
- 2 LED, Blue, D41,D42
- 6 LED, Rt. Angle, PCB, Green, D52,D51,D50,D49,D48,D47
- 4 LED, Rt. Angle, PCB, Red, D46,D45,D44,D43

**SEMICONDUCTORS**

- 3 MPSA42 Transistors (marked MPSA42), Q1,Q2,Q3
- 1 MPSA92 Transistor (marked MPSA92), Q4
- 1 2N2222 Transistor (marked PN2222A or MPS2222A ), Q6
- 1 MJE350 Transistor (marked MJ3350), Q5
- 1 MJE340 Transistor (marked MJE340), Q7
- 2 IXFH16N50P MOSFET (marked IXFH16N50P), Q8,Q12
- 1 IXDD414CI or IXDD614CI (marked IXDD414CI or IXDD614CI), U1

**INTEGRATED CIRCUITS (ICs)**

- 1 12V Regulator (marked LM7812), U2
- 1 LM3914 or LM3916 Dot / Display Driver, 18DIP, U42
- 1 4MHz Oscillator, XTAL1

**MISCELLANEOUS**

- 7 Screw Terminals
- 1 RCA Rt. Angle, PCB Connector, J1
- 1 Power Transformer, PCB Mount, T41
- 1 Power Transformer, T42
- 1 2.2" DIA Secondary Coilform
- 1 3.1" DIA Primary Coilform
- 1 Plywood Centering Ring for Coilforms
- 1 22AWG Magnet Wire
- 1 Powdered Iron Core, L1
- 1 Primary Wire, 14 AWG
- 1 Heatsink Extrusion, Aluminum
- 1 Misc. Hardware
- 2 AC Power Cord

- 4 Fuse Clip, PC Mount
- 1 Fuse, 1A, 5x20mm, Fast Acting, F41
- 1 Fuse, 3A, 5x20mm, Fast Acting, F42

**REQUIRED, NOT SUPPLIED**

- 1 Fan, Cooling (preferably 115VAC muffin fan)
- A/R Electrical Tape or Wire Nuts
- A/R Two-Part Epoxy or similar adhesive
- A/R Sandpaper

**RECOMMENDED, NOT SUPPLIED**

- 1 Enclosure for Class-E Audio Modulated Tesla Coil Board
- 1 Plastic Wire Tie

Class-E Tesla Coil - Component Layout Diagram

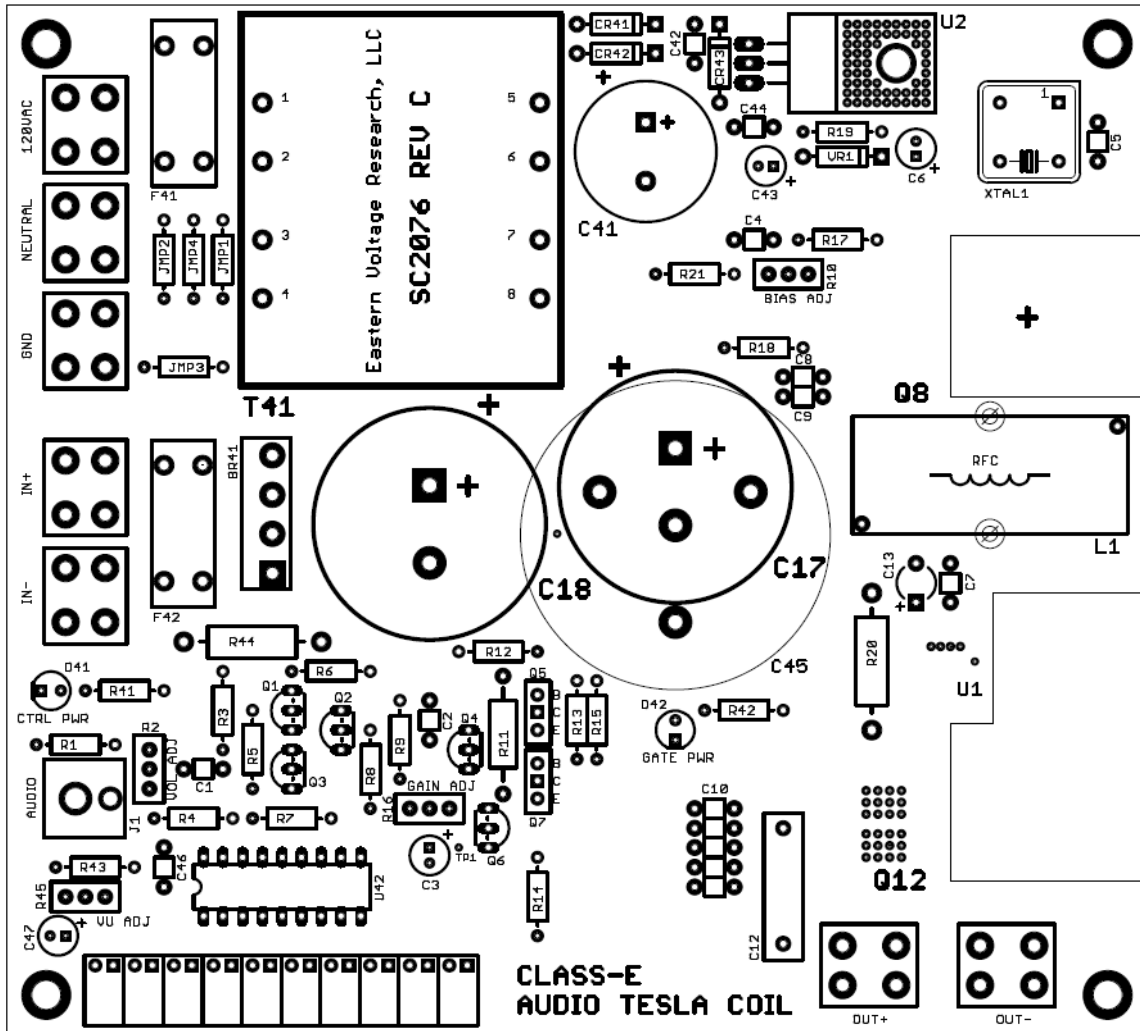

Note: Your kit will be supplied with either a single 8200uF-10000uF, 100V electrolytic capacitor (OPTION 1) or two 4700uF, 100V electrolytic capacitors (OPTION 2) depending on capacitor availability. For OPTION 1, only C45 is installed in the C45 location. For OPTION 2, both C17 and C18 will be installed in their respective locations.

## **KIT Building Instructions**

Now we will begin building the kit. There are just a few more important things to know before we install the first components.

For each component, the word “install” always means the following:

1. Pick the correct value to start with.
2. Insert the component into the correct printed circuit board (PCB) location.
3. Orient the component correctly – especially when there is a right and a wrong way to solder it in. (i.e. Electrolytic capacitors, diodes, ICs, transistors, etc...)
4. Solder all connections unless directed otherwise. Ensure enough heat is used to allow solder to flow for clean, shiny, and completed connections.

Also, please be sure to take us seriously when we say that good soldering is the key to the proper operation of your circuit!

- Use a 25W soldering pencil with a clean, sharp tip. DO NOT USE a high power soldering gun such as those trigger activated units.
- Use only rosin core solder intended for electronics use
- Ensure your work area is clean, and has plenty of bright lighting
- Build your kit in stages, taking breaks to check your work. Be sure to clean the board periodically with a brush or compressed air to remove any excess wire cuttings, etc...

Okay, so lets begin!

- 1. Install R1, 10k resistor (brown-black-orange)
- 2. Install R6, 10k resistor (brown-black-orange)
- 3. Install R18, 10k resistor (brown-black-orange)
- 4. Install R3, 330k resistor (orange-orange-yellow)
- 5. Install R4, 390k resistor (orange-white-yellow)
- 6. Install R5, 2.2k resistor (red-red-red)
- 7. Install R8, 2.2k resistor (red-red-red)
- 8. Install R12, 2.2k resistor (red-red-red)

- 9. Install R15, 2.2k resistor (red-red-red)
- 10. Install R7, 1.8k resistor (brown-gray-red)
- 11. Install R9, 100k resistor (brown-black-yellow)
- 12. Install R11, 68k, 1/2W resistor (blue-gray-orange)
- 13. Install R13, 150 ohm resistor (brown-green-brown)
- 14. Install R14, 150 ohm resistor (brown-green-brown)
- 15. Install R17, 1k resistor (brown-black-red)
- 16. Install R19, 220 ohm resistor (red-red-brown)
- 18. Install R20, 1.6 ohm, 2W, resistor (brown-blue-gold)
- 19. Install R41, 1.5k resistor (brown-green-red)
- 20. Install R42, 820 ohm resistor (gray-red-brown)
- 21. Install R43, 634 ohm resistor (blue-orange-yellow-black-brown)
- 22. Install R44, 120k, 2W resistor (brown-red-yellow)
- 23. Install R21, 200k resistor (red-black-yellow)

**For 115VAC 50/60Hz Only**

- 24. If your available electric power is 115VAC 50/60Hz, as is the case with those living in the United States or Canada, please install jumpers at the following locations:

JMP1, JMP2, JMP3

Use the discarded (cut) leads from the resistors installed in the previous steps as jumpers.

For those living in European (or similar) countries that utilize a 230VAC 50/60Hz standard, please refer to the schematic for proper jumper installation. Also, note that you will also require a 230VAC transformer which is not included in our kits.

- 25. Install C5, 0.1uF capacitor (marking BC104)

- 26. Install C7, 0.1uF capacitor (marking BC104)
- 27. Install C9, 0.1uF capacitor (marking BC104)
- 28. Install C42, 0.1uF capacitor (marking BC104)
- 29. Install C44, 0.1uF capacitor (marking BC104)
- 30. Install C46, 0.1uF capacitor (marking BC104)
- 31. Install C1, 0.47uF capacitor (marking BC474)
- 32. Install C4, 0.47uF capacitor (marking BC474)
- 33. Install C2, 68pF capacitor (marking BC68)
- 34. Install C8, 1uF capacitor (marking BC105 or M39014/2-1407 or M39014/2-1415)
- 35. Install C10, 560pF capacitor (marking M39014/01-1233)
- 36. Install C12, 4.7nF, 630V capacitor (marking 4n7 J630)
- 37. Install C3, 22uF, 63V electrolytic capacitor. C3 has “polarity.” Polarity means the capacitor must be inserted a certain way. You may notice that one side of the capacitor, there is a black stripe with minus signs. This is the negative end. Looking at the PCB silkscreen, you will notice the positive side marked. Install this capacitor into the board ensuring the positive side of the capacitor installs in the hole that is marked positive on the PCB layout.
- 38. Install C6, 10uF, 50V electrolytic capacitor. Install this capacitor into the board ensuring the positive side of the capacitor installs in the hole that is marked positive on the PCB layout.
- 39. Install C43, 10uF, 50V electrolytic capacitor. Install this capacitor into the board ensuring the positive side of the capacitor installs in the hole that is marked positive on the PCB layout.
- 40. Install C47, 10uF, 50V electrolytic capacitor. Install this capacitor into the board ensuring the positive side of the capacitor installs in the hole that is marked positive on the PCB layout.
- 41. Install C13, 10uF, 35V tantalum capacitor (marking 10635). Install this capacitor into the board ensuring the positive side of the capacitor installs in the

hole that is marked positive on the PCB layout. The positive side of this capacitor is denoted by the “+” marking.

- 42. Install VR1, 1N4733 5.1V zener diode. The cathode band on the diode must match that shown on the silkscreen.
- 43. Install CR41, 1N4002 diode. The cathode band on the diode must match that shown on the silkscreen.
- 44. Install CR42, 1N4002 diode. The cathode band on the diode must match that shown on the silkscreen.
- 45. Install CR43, 1N4002 diode. The cathode band on the diode must match that shown on the silkscreen.
- 46. Install D41, LED. The short lead of the diode is the cathode and will install into the square pad on the PCB board.
- 47. Install D42, LED. The short lead of the diode is the cathode and will install into the square pad on the PCB board.
- 48. Install BR1, bridge rectifier (marking KBL04, KBL06, or KBL08). The notched end of BR1 is the positive pin and must be installed in the square pad in the PCB board.
- 49. Install LEDs, D43-D52. The first step to installing these VU meter LEDs is to assemble them first. Connect them together, using the dovetail joints on each LED, with the six (6) green LEDs on the left and the four (4) red LEDs on the right. Once connected by hand, use a flatedge to press them all in alignment vertically. Carefully insert the ten (10) LED assembly into the holes in the board and solder from beneath.
- 50. Install Q1, MPSA42 transistor. This transistor needs to be orientated properly. Please insert Q1 into the board with the flat edge of the transistor orientated according to the silkscreen layout drawing.
- 51. Install Q2, MPSA42 transistor. This transistor needs to be orientated properly. Please insert Q2 into the board with the flat edge of the transistor orientated according to the silkscreen layout drawing.
- 52. Install Q3, MPSA42 transistor. This transistor needs to be orientated properly. Please insert Q3 into the board with the flat edge of the transistor orientated according to the silkscreen layout drawing.

- ❑ 53. Install Q4, MPSA92 transistor. This transistor needs to be orientated properly. Please insert Q4 into the board with the flat edge of the transistor orientated according to the silkscreen layout drawing.
- ❑ 54. Install Q6, MPS2222A transistor (marked 2N2222A, PN2222A, or MPS2222A). This transistor needs to be orientated properly. Please insert Q6 into the board with the flat edge of the transistor orientated according to the silkscreen layout drawing.
- ❑ 55. Install Q5, MJE350 transistor. This transistor needs to be orientated properly. Use the figure below to correctly orientate this transistor into the PC board. The three dots designate the front of the device. Install the device ensuring the emitter, collector, and base match that to the silkscreen on the PCB board.

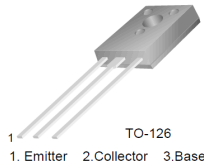

- ❑ 56. Install Q7, MJE340 transistor. This transistor needs to be orientated properly. Use the figure below to correctly orientate this transistor into the PC board. The three dots designate the front of the device. Install the device ensuring the emitter, collector, and base match that to the silkscreen on the PCB board.

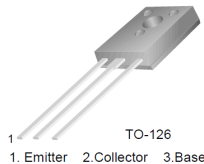

- ❑ 57. Install XTAL1, 4MHz Oscillator. The sharp 90 degree corner of the device must be installed so it matches the sharp 90 degree corner on the silkscreen. This corner designates Pin 1 of the device.
- ❑ 58. Install U2, LM7812 Linear Regulator. This component must be installed with the included heatsink and hardware. The easiest way to solder this to the board is to first attach the component and heatsink / hardware to the board, ensuring the leads on U2 are properly bent (formed) to align with the solder holes and heatsink mounting hole. Once the heatsink assembly is attached, the three (3) leads of the LM7812 can be soldered to the PCB. Be sure not to bend the leads more than once as they will break! Use the supplied 6-32 x 3/8" length panhead screw and 6-32 nut to secure U41 to the board.

- 59. Install U42, LM3914 (or LM3916) Dot/Display Driver. The LM3914 (or LM3916) may be soldered directly to the PCB without worry, but you may use an 18-pin DIP socket (not supplied) if you prefer. Use the same care in soldering such a socket and inserting the IC as you would in direct soldering of the chip. Note that one end of the IC is marked by a dot, notch, or band; this end **MUST** be oriented as shown on the PCB layout.
- 60. Install the (7) screw terminals. Note that the bottom lefthand side GND terminal is not populated. This is shown on the hook-up diagram on page 26.
- 61. Install 10k potentiometer, R2. (marking 103)
- 62. Install 10k potentiometer, R16. (marking 103)
- 63. Install 10k potentiometer, R45. (marking 103)
- 64. Install 100k potentiometer, R10. (marking 104)
- 65. Install the two (2) fuse clips in the board location designated F41 on the PCB board. Note, that there are end-stops on each of these clips which must be facing the outside when installed, or the fuse will not install properly.
- 66. Install the two (2) fuse clips in the board location designated F42 on the PCB board. Note, that there are end-stops on each of these clips which must be facing the outside when installed, or the fuse will not install properly.
- 67. Install the 1A fuse into the F41 fuse clips.
- 68. Install the 1A fuse into the F41 fuse clips.
- 69. Install RCA connector, J1. There are two black plastic tabs underneath this connector that should be cut off to ensure the connector sits flat on the board.
- 70. Build drain choke, L1. Using the included toroid core (red), wind 25 turns around this using the included 22 AWG magnet wire. The core should be wound so that the 25 turns are distributed evenly around the ENTIRE core. Using sandpaper (not supplied), remove the enamel from the two ends of the winding and install and solder to the board at location L1. Use a plastic wire tie (not supplied), to secure the inductor to the board in the two mounting holes provided.
- 71. Install C41, 2200 – 4700uF, 35V electrolytic capacitor. Install this capacitor into the board ensuring the positive side of the capacitor installs in the hole that is marked positive on the PCB layout.

- 72a. Install C45, 8200-10000uF, 100V electrolytic capacitor. Install this capacitor into the board ensuring the positive side of the capacitor installs in the hole that is marked positive on the PCB layout. (OPTION 1)
- 72b. Install C17 and C18, 4700uF, 100V electrolytic capacitors. Install these capacitors into the board ensuring the positive side of the capacitor installs in the hole that is marked positive on the PCB layout. (OPTION 2)
- 73. Install T41, 24VAC control transformer. This transformer needs to be orientated correctly. Ensure that the pin numbers on the side of the transformer match those marked on the silkscreen on the PCB board.
- 74. Install (4) 6-32 x ¼” standoffs to the extruded aluminum heatsink using the included 6-32 x 5/16” flathead screws. The standoffs will install in the (4) corners of the extruded aluminum heatsink.
- 75. Install PCB board to the (4) stand-offs using the included 6-32 x 3/16” panhead screws. Ensure that the threaded holes in the heatsink line up with the locations of Q8, U1, and Q12 on the PCB board.
- 76. Install the (3) thermal insulators to the Q8, U1, and Q12 locations on the extruded aluminum heatsink.
- 77. Install Q8, IXFN16N50P to the extruded aluminum heatsink using the included 6-32 x 3/8” panhead screw. You will need to bend the leads upward to that they extend upwards onto the (3) pads on the PCB board. Trim the (3) component leads to the proper length so that they don’t overextend past the pads on the PCB board. Ensure that the device is sitting flatly on the thermal pad and that the panhead screw is tightened securely. Failure to do this will result in premature failure of the device due to overheating. Finally, use a multimeter to ensure that pin 2 of the device is not shorted to the heatsink.
- 78. Install Q12, IXFN16N50P to the extruded aluminum heatsink using the included 6-32 x 3/8” panhead screw. You will need to bend the leads upward to that they extend upwards onto the (3) pads on the PCB board. Trim the (3) component leads to the proper length so that they don’t overextend past the pads on the PCB board. Ensure that the device is sitting flatly on the thermal pad and that the panhead screw is tightened securely. Failure to do this will result in premature failure of the device due to overheating. Finally, use a multimeter to ensure that pin 2 of the device is not shorted to the heatsink.
- 79. Install U1, IXDD414CI to the extruded aluminum heatsink using the included 6-32 x 3/8” panhead screw. You will need to bend the leads upward to that they extend upwards onto the (5) pads on the PCB board. Trim the (5) component leads to the proper length so that they don’t overextend past the pads on the PCB

board. Ensure that the device is sitting flatly on the thermal pad and that the panhead screw is tightened securely. Failure to do this will result in premature failure of the device due to overheating.

- 80. Now the fun part – winding the secondary coil. Using the figure below, wind the secondary coil using the included 2.2” secondary coilform and 22 AWG spool of wire. First place the spool of wire on a stationary rod so that it can spin freely. Next, either manually holding the secondary in your hand, or using a winding jig (built by user) wind a few extra turns at the base of the secondary and use masking or electrical tape to hold in place. **Be sure to leave about 14” of 22 AWG at the bottom of the secondary as this will be used to connect the secondary RF ground to the PCB board screw terminal.** Begin winding the secondary at the locations shown in the figure below. Continue winding the secondary, ensuring each wind is neat and tightly together with adjacent windings, for the entire length as indicated in the figure below. Adding masking tape every inch or so will ensure the windings don’t unwind and also allows you to take rests if needed. Once you are completed, tape off the end of the winding, and finally add a few extra turns. Do not coat the secondary coil at this time. You will first need to tune the coil for proper operation and may need to adjust the number of turns.

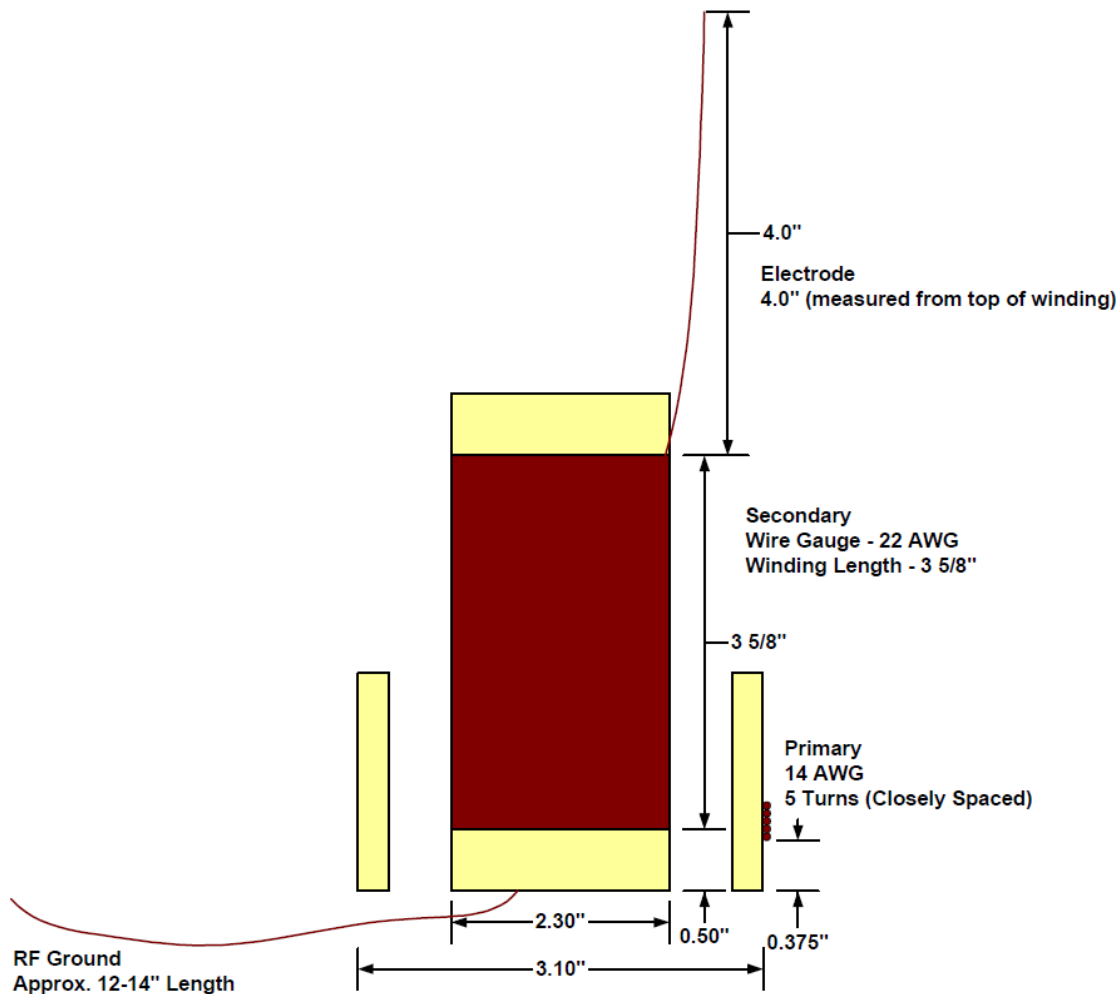

- 81. Form the top wire of the secondary into a discharge electrode as shown in the figure above. For initial tuning, it is extremely important that the wirelength is precisely the length as shown in the figure above.
- 82. Using the included 3.1" DIA primary coilform and 14 AWG wire, wind the primary coil as shown in the figure above. It is especially important to ensure the proper dimensioning of the primary coil as this is crucial to the operation and tuning of the Class-E Tesla coil. The primary coil can then be secured in place using masking or electrical tape (not supplied), or two-part epoxy (not supplied).

**DO NOT connect the primary coil to the PCB board at this time.**

- 83. Using five-minute epoxy (not supplied) or similar adhesive, attach the primary coil to the secondary coil using the included plywood centering ring.

- 84. Connect AC power cord to the board as shown in the figure below. This AC power cord provides control power to the PCB board and connects do screw terminals marked, “120VAC”, “NEUTRAL”, and “GND.” It is especially important to connect the GND wire of the AC power cord to the screw terminal marked “GND” as this ensures all the circuitry and heatsink are properly grounded to earth ground.

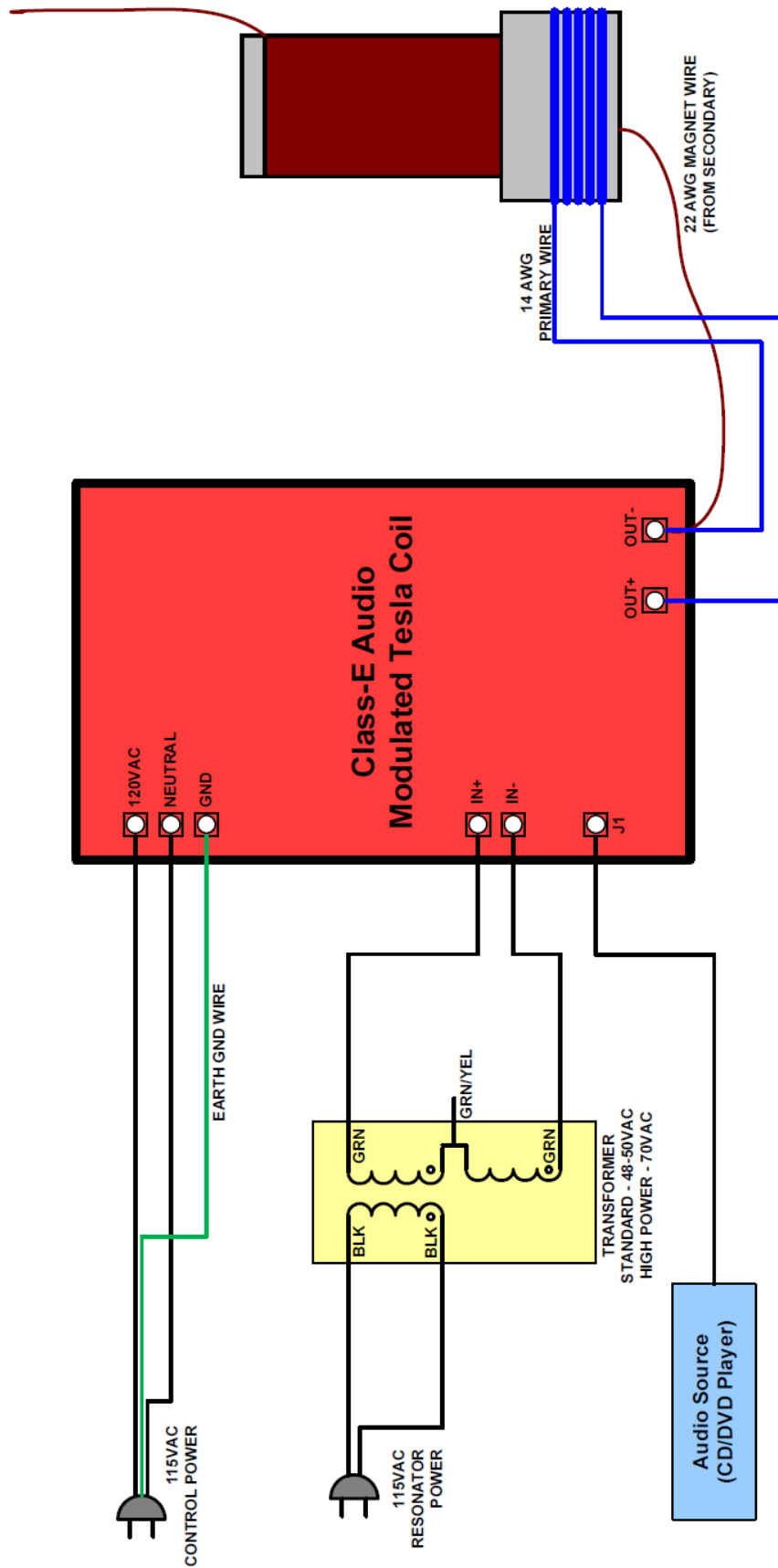

- ❑ 85. Connect T42, power transformer as shown in the figure above. Use electrical tape or wirenuts (not supplied) to secure and insulate the connections between the power transformer and AC power cord. Be sure to use the correct figure below according to the specific kit you have purchased. Note: If you are on a 220VAC power grid (i.e. Europe), you will need to supply your own 220VAC power transformer. We recommend a 220VAC 50/60Hz primary input transformer with an output of 48VAC-70VAC with a minimum current output of 2A for this use.



**If you are on a 220VAC power grid (i.e. Europe), you will need to supply your own 220VAC power transformer. We recommend a 220VAC 50/60Hz primary input transformer with an output of 48VAC-70VAC with a minimum current output of 2A for this use.**

- ❑ 86. Connect a line-level audio source to the RCA input connector, J1, on the PCB board. It is highly recommended that to use an old AC powered CD or DVD player.



**We do not recommend the use of portable electronics to provide audio signals for this particular design. This includes, and is not limited to, battery powered MP3 players, Smart Phones, and Laptop Computers. We strongly recommend the use of an old AC powered CD or DVD player as these work best.**

Congratulations! You have just completed your Class-E Audio Modulated Tesla Coil kit. Please take a few moments to look over the board and ensure that all the components are installed properly with the correct orientation. Since some of the parts may be unfamiliar to you, you may want to be extra sure that they have been inserted correctly. After you are sure that everything seems to be properly installed, move on to the set-up and testing section.

## Set-up and Testing

Okay, so lets begin!

### RECOMMENDED TEST EQUIPMENT, NOT SUPPLIED

- 1 Analog or Digital Multimeter



**Please be sure to wear safety glasses when testing and operating the Class-E Audio Modulated Tesla Coil**



**The Output Arc of the Tesla Coil is extremely hot. Never attempt to touch the arc or draw arcs using any type of object.**



**The Extruded Aluminum Heatsink may get extremely hot during operation. Ensure that the heatsink is placed on something non-flammable, preferably metal.**

- 1. After putting on your safety glasses, plug in the Control Power AC power cord. This is the AC power cord that goes to the terminals marked “120VAC”, “NEUTRAL”, and “GND” on the PCB board. Using a multimeter, verify that the following voltages are correct. If they are not, then there is a problem with your circuit that needs to be diagnosed and corrected. Note: The number in parentheses are actual measured numbers from the baseline design, however your results may vary slightly.

**DO NOT connect the HV Resonator Power Cord at this time!**

**DO NOT connect the primary coil to the PCB board at this time.**

Check	Component	Measuring Point	Voltage
<input type="checkbox"/>	U2, LM7812	Pin 1 (Input)	18V ± 4V (16.85V)
<input type="checkbox"/>	U2, LM7812	Pin 3 (Output)	12V ± 0.5V (12.15V)
<input type="checkbox"/>	U42, LM3914/LM3916	Pin 3 (Vcc)	12V ± 0.5V (12.15V)
<input type="checkbox"/>	VR1, 1N4733	Cathode Side	5.1V ± 0.5V (4.93V)
<input type="checkbox"/>	U1, IXDD414CI	Pin 1 (Vcc)	12V ± 0.5V (12.15V)

Note: All voltages should be measured with respect to the GND screw terminal.

- 2. Verify that both LEDs, D41 and D42, are illuminated. If they are not, and the voltages above are correct, they may be installed backwards.
- 3. Unplug the Control Power AC power cord.
- 4. This step involves disconnecting the load from the Q8 linear regulator. To do this, lift one lead from the board of drain choke, L1. Simply heat up the wire connection and lift the lead from the PCB board. This disconnects Q8 from the load.
- 5. The next step involves setting the output voltage of the Q8 linear regulator to 100V. (*If you have a standard version using the 50VAC transformer, then this voltage should be approx. 70V*) Using your multimeter, monitor the voltage from Q8, Pin 3 (Source) to the GND screw terminal.
- 6. Plug in the Control Power AC power cord.



**Please be sure to wear safety glasses when testing and operating the Class-E Audio Modulated Tesla Coil**

- 7. Plug in the Resonator Power AC power cord.
- 8. Adjust R10, BIAS ADJ potentiometer until the Q8, Pin 3 (Source) voltage is approximately 100V. (*If you have a standard version using the 50VAC transformer, then this voltage should be approx. 70V*) This will be the voltage when the potentiometer is maxed out.
- 9. Unplug the Resonator Power AC power cord.
- 10. Unplug the Control Power AC power cord.

**You are now ready to test the Class-E Tesla Coil and tune your Tesla Resonator.  
Please review the following warnings before proceeding:**



**The Output Arc of the Tesla Coil is extremely hot. Never attempt to touch the arc or draw arcs using any type of object.**



**Protective Eyewear is REQUIRED at all times when operating the Class-E Audio Modulated Tesla Coil.**

**DO NOT stand close to the Class-E Audio Modulated Tesla Coil system when Resonator Power is applied. Stand back at least five (5) feet from the Class-E Audio Modulated Tesla Coil system.**

- 11. With all power disconnected, reconnect the drain choke, L1, lead to the PCB that was previously disconnected in Step 4.



**DO NOT operate the Class-E Board with Resonator Power applied without the Tesla Resonator attached. The Class-E power stage must always be properly loaded or the MOSFETs, Q8 and Q12 may fail.**

- 12. Ensure that the resonator is built according to the figure previously shown. Ensure the primary and secondary windings are built within specification (proper dimensioning followed) and that the length of the upper electrode is also correct. This is extremely important as it affects the tune of the Tesla coil.
- 13. Connect the Tesla Resonator to the Class-E PCB board as shown in the figure shown previously. The primary should connect to the terminals marked “OUT+” and “OUT-“ on the PCB board. The bottom 22 AWG wire of the secondary coil should be connected directly to the “OUT-“ terminal of the PCB board. Be sure to use the sandpaper to remove the enamel from the secondary 22 AWG wire before connecting it to the screw terminal.

- 14. Plug in the power for the fan and ensure it is blowing across the heatsink, parallel to the fins. Also ensure that the heatsink is not sitting on top of any flammable materials such as plastic or paper.
- 15. Plug in the Control Power AC power cord.
- 16. Stand at least five feet away, and also ensuring you have safety glasses on, plug in the Resonator Power AC power cord. If the resonator was built according to the dimensions provided, you should see output arc appear on the electrode of the Tesla Resonator. Congratulations! Please skip to step 25 below to continue with the fine tuning process. Unplug the Resonator Power AC power cord. Unplug the Control Power AC power cord.
- 17. If you did not have any high voltage output appear in the previous step, you will need to determine if the tuning was correct or not. The first thing to do is to ensure that all the wiring was connect and the Tesla Resonator was built according to the specifications provided. This includes the top length of the electrode. If the wiring is all correct, we will proceed with the tuning procedure.



**Please note that there should be no reason that you shouldn't get high voltage output provided you followed the proper dimensioning when constructing your Tesla Resonator. If you do not have high voltage output at this point, you either have Tesla Resonator that is not properly constructed, or an electrical problem elsewhere in the circuit. Steps 18-24 should only be followed if you are confident the Tesla Resonator is built to proper dimensions and the circuit is working properly (no failures, etc...)**

- 18. Remove some of the upper turn of the secondary coil and make an electrode that is approximately 8" high. It should stick straight up in the air and not bend downward.
- 19. Plug in the Control Power AC power cord.
- 20. Plug in the Resonator Power AC power cord.
- 21. Observe the electrode and observe if there is any corona visible. A darkened room will make this observation much easier. Only apply power for a few seconds. Unplug the Resonator Power AC power cord and Control Power AC power cord.



**Be sure to TURN OFF all power before trimming or touching the resonator! This includes both the Resonator Power and Control Power!**

- 22. If no corona was visible, or only a very slight amount was visible, trim the electrode by approximately 0.25". Repeat steps 19-22.
- 23. If you begin to see corona, skip to step 25 below.
- 24. If the wire is already cut completely to the bottom and no corona was seen, you need to increase the resonant frequency of the coil a bit more. This can be done by removing about 10 turns of the secondary coil from the top. Once you remove 10 turns, repeat this process beginning at step 18 above.
- 25. If you start seeing a little bit of corona, you are close to the proper tuning point. Continue trimming the wire in 0.1" increments until maximum arc length is seen. Maximum arc length will be about 1-2" (depending on version you have) for this particular design. If you start trimming the wire, and arc length begins decreasing, you are past the optimum tuning point. In this case, simply lengthen the electrode wire (just a little bit) by unraveling the top turn of the secondary and making the wire a little higher again. Continue to repeat this process until you are satisfied you have a good tuning point. When completed, unplug both the Resonator Power and Control Power AC power cords.
- 27. At this time, you will modify the straight wire electrode into the circular loop as shown in the figure below. The loop will provide much more audio volume as well as visual effect due to increased surface area of the electrical arc. To create the loop, simply form a loop approximately 1" in diameter using the existing magnet wire electrode and bend it back over itself. Apply solder to secure the loop as shown in the figure below. Try to keep this connection point as small and neat as possible. Once that is completed, simply unravel the wire from the secondary just enough to make the top of the loop the EXACT same height as was previous with the tuned straight wire configuration. This ensures the tuning is correct.

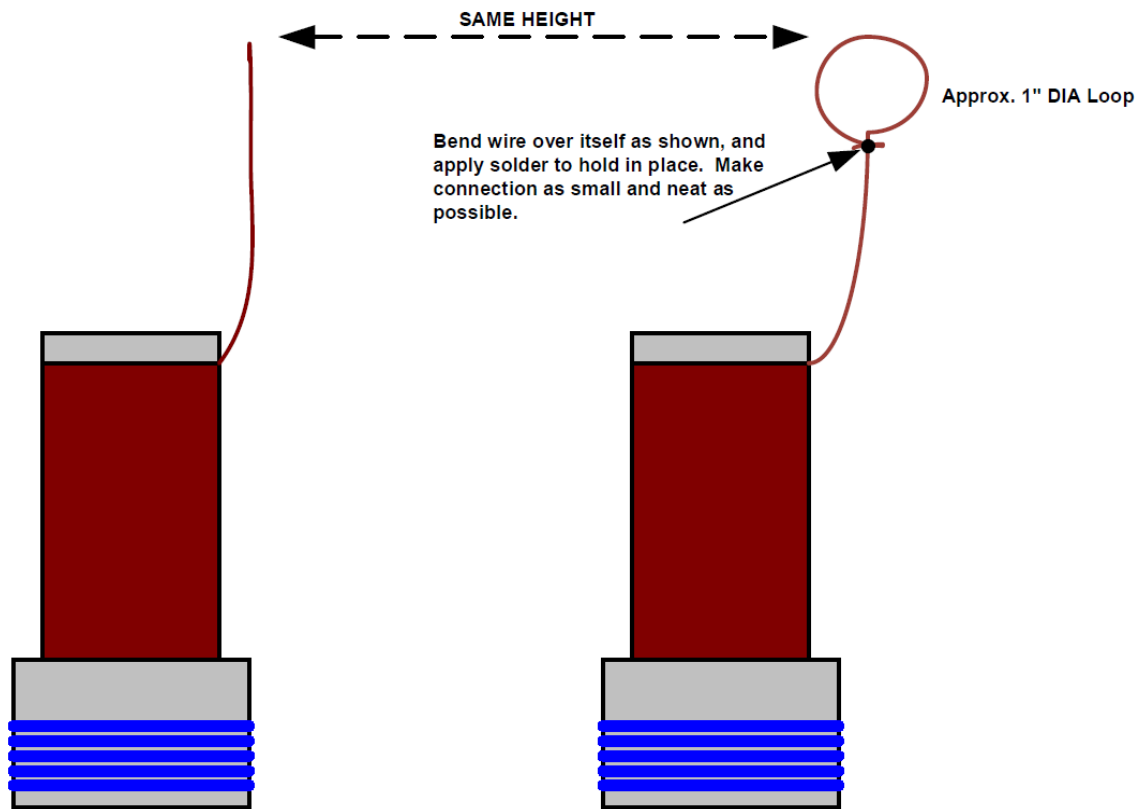

- 28. Plug in the Control Power AC power cord.
- 29. Plug in the Resonator Power AC power cord.
- 30. Verify that the loop electrode configuration is working properly and providing high voltage output. Fine tune as necessary by repeating step 25. However, this is usually not necessary provided the height of the loop is the same as the height of the straight wire electrode.
- 31. Unplug the Resonator Power AC power cord.
- 32. Unplug the Control Power AC power cord.
- 33. At this point we recommend securing the windings with epoxy or even coating the entire secondary coil with polyurethane furniture polish to protect the windings and prevent them from unraveling.

**Your Tesla Resonator should now be properly tuned and ready for audio modulation. The next several steps will help you set-up your Class-E circuit for the initial audio modulation testing.**

- 34. You will now disconnect the load from the Q8 linear regulator again. To do this, lift one lead from the board of drain choke, L1. Simply heat up the wire connection and lift the lead from the PCB board. This disconnects Q8 from the load.
- 35. The next step involves setting the output voltage of the Q8 linear regulator to 85V. *(If you have a standard version using the 50VAC transformer, then this voltage should be approx. 59V)* Using your multimeter, monitor the voltage from Q8, Pin 3 (Source) to the GND screw terminal.
- 36. Plug in the Control Power AC power cord.



**Please be sure to wear safety glasses when testing and operating the Class-E Audio Modulated Tesla Coil**

- 37. Plug in the Resonator Power AC power cord.
- 38. Adjust R10, BIAS ADJ potentiometer until the Q8, Pin 3 (Source) voltage is approximately 85V. *(If you have a standard version using the 50VAC transformer, then this voltage should be approx. 59V)*
- 39. Unplug the Resonator Power AC power cord.
- 40. Unplug the Control Power AC power cord.
- 41. With all power disconnected, reconnect the drain choke, L1, lead to the PCB that was previously disconnected in Step 33.
- 42. The following steps involve setting the adjustment potentiometers to their default starting locations. Using the figure below, attach the multimeter as shown and adjust the VOL ADJ potentiometer, R2, until you measure approximately 0 ohms across the measurement points. The actual value may vary, but should be less than 100 ohms ideally.
- 43. Using the figure below, attach the multimeter as shown and adjust the VU ADJ potentiometer, R45, until you measure approximately 600 ohms. This measurement will be the resistance between pins 4 and 6 of U42.

- 44. Using the figure below, attach the multimeter as shown as adjust the GAIN ADJ potentiometer, R16, until you measure approximately 1.22k ohms. This measurement will be the resistance between the bottom lead of R8 and the test point to the right of R16 marked “TP1.”

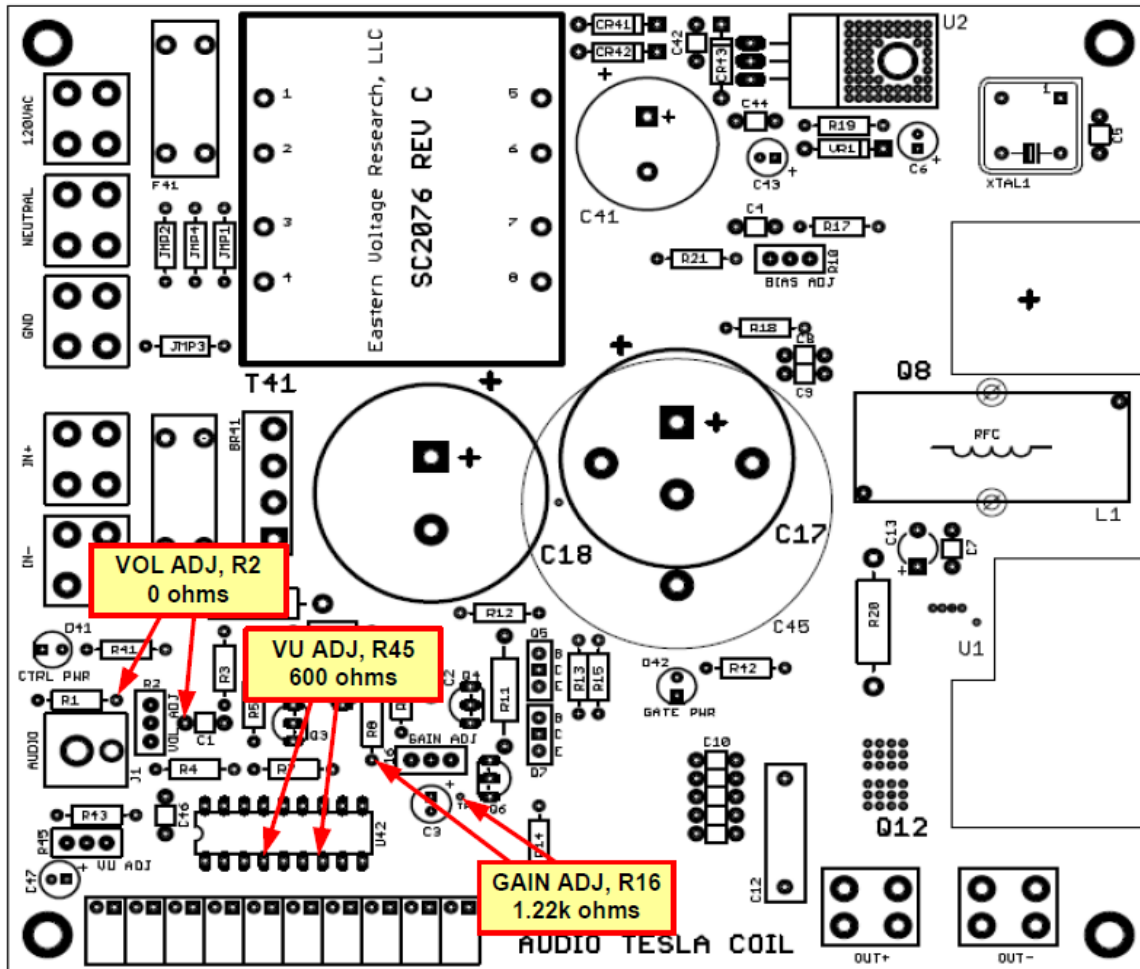

- 45. You will now test your audio source. Connect a CD/DVD Player to the audio input, J1, using an RCA audio cable (not supplied). Insert CD of your choice.
- 46. Plug in the Control Power AC power cord.
- 47. Turn on the CD/DVD Player and play a track off your chosen CD.
- 48. The default setting for the 10-Step LED VU Meter is at its maximum. Therefore, you should be seeing audio illuminated feedback on the 10-Step LED VU Meter indicating audio is being input into the board. If you do not see any

LEDs illuminate on the VU Meter, then there is a problem with your audio source. Please note, that some DVD players do not have the audio output enabled initially, and this must be set in the MENU for the DVD player.

- 49. This step involves setting up the threshold levels for the onboard VU LED meter. With the audio source playing a track, adjust potentiometer, R45, until the VU meter LEDs are illuminated to the desired level. Typically, you would adjust R45 until the musical peaks just illuminate the farthest red LED.
- 50. Unplug the Control Power AC power cord.

**You are now ready to test the audio modulation of the Class-E Tesla Coil.**

- 51. Again, make sure power for the fan is plugged in and ensure it is blowing across the heatsink, parallel to the fins. Also ensure that the heatsink is not sitting on top of any flammable materials such as plastic or paper.
- 52. Plug in the Control Power AC power cord.
- 53. Plug in the Resonator Power AC power cord.
- 54. At this point, you should have high voltage output on your Tesla Resonator.
- 55. Turn on the CD/DVD Player and play a track of your chosen CD.
- 56. Play audio through the CD player. You should now be able to hear audio through the arc. Impressive eh? The following potentiometers may be adjusted to fine tune the audio modulation of the Tesla coil.

#### **VOL ADJ, R2 Potentiometer**

This adjusts the input audio signal level. The DEFAULT setting for this potentiometer is at its maximum and this potentiometer usually never needs to be changed by the user. However, you can try adjusting it and seeing how the audio volume changes with adjustment. Again, for line-level audio output, this should always be set to its maximum setting.

#### **VU ADJ, R45 Potentiometer**

This adjusts the VU Meter sensitivity. This only adjusts the sensitivity of the 10-step LED VU meter. It has no affect on the audio modulation of the Class-E Tesla Coil.

#### **GAIN ADJ, R16 Potentiometer**

This adjusts the gain of the onboard audio amplifier which is used to modulate MOSFET, Q8. Decreasing the gain will decrease the audio volume, while increasing the gain will increase the volume. However, if

you increase the gain too much, you will start hearing distortion. If you hear distortion, simply decrease the gain. To set this properly simply increase the gain until volume is maximized and no distortion is present.

#### **BIAS ADJ, R10 Potentiometer**

This adjusts the bias voltage output of the Q8 linear regulator. It is initially set to 85V (no load). *(If you have a standard version using the 50VAC transformer, then this voltage should be approx. 59V)* We do not recommend the user to change this unless they have a strong understanding of how the entire circuit works. Decreasing the bias voltage will allow a wider modulation envelope, but also increase heat dissipation of Q8. If this voltage is set too low, Q8 may fail thermally. If you do wish to adjust this, we recommend decreasing the voltage only slightly, and then re-adjusting the GAIN ADJ, R16 potentiometer to increase gain and modulation envelope to help increase volume. But for the general user, we do not recommend this potentiometer be changed.

Congratulations, you have now completed the testing of the Class-E Audio Modulated Tesla Coil!

### **General Operation Instructions**

1. To turn ON your Class-E Tesla Coil, please follow the recommended steps below:

- Apply FAN Power
- Plug-in Control Power
- Plug-in Resonator Power
- Enable Audio

Note: Control Power and Resonator Power may be applied simultaneously.

2. To turn OFF your Class-E Tesla Coil, please follow the recommended steps below:

- Disable Audio
- Unplug Resonator Power
- Unplug Control Power
- Turn OFF fan

Note: Control Power and Resonator Power may be turned OFF simultaneously.

3. Because the heatsink and resonator get warm, we recommend that the Class-E coil only be used for a single song, and allow the Class-E coil to cool down for a period of the same duration. This is called 50% duty cycle operation.

Class-E Coil Operation for Music Piece A (2 minutes)

Turn OFF Class-E Coil for 2 minutes

REPEAT

### **Tips / Fine Tuning**

Use the following tips to fine tune your system and maximize performance.

1. The most important thing you can do to improve performance is two run two (2) coils in stereo. I cannot stress how much of a difference this makes in both volume and sound quality. The imaging is absolutely incredible and the sound is both louder and much higher quality as well.
2. Ensure primary is always centered
3. Raising and lowering primary can improve arc length and increase output. However, if primary is raised too high, and you start hearing distortion, you are likely operating outside the Class-E range of proper operation. If this occurs, simply lower the primary winding slightly. Also, with increased coupling, you will draw more current from your Resonator Power transformer. If you have an oscilloscope, you can verify correct tuning and coupling by comparing the Q12 Drain-to-Source waveforms to those in the end of this instruction manual.
4. Retune the secondary periodically to maintain maximum tune. Follow the process outlined above. Although since you are already tuned, you only need to adjust the existing height by very slight amounts.
5. Also note that the location of nearby objects can affect the tuning point. For example, your hands, a metallic object, wall, etc... can affect the tuning. So if you tune in one location and then move to another, you may have to adjust the tune slightly.

### **Improving Audio Quality**

There are a few ways to vastly improve the audio quality of your Class-E Audio Modulated Tesla Coil:

1. The number one way to increase both audio quality and volume is to use a stereo pair of Class-E Audio Modulated Tesla Coils. The stereo imaging from this arrangement is absolutely incredible and guaranteed to be like nothing you've heard before. Each Class-E Tesla Coil acts as a omni-directional point source (unlike traditional uni-directional axial tweeters), and with your eyes closed, it is impossible to determine the location of where the audio is coming from.
2. Use an equalizer. With an equalizer, you can vary the gains of various frequencies and reduce the distortion that may be produced. You will also increase the bass response

of your system by tuning it with an equalizer. An equalizer also has a pre-amp which can boost the output level of the audio source. This is especially important for audio sources which have a low output level.

3. Experiment with many CDs. Each CD has its own mixing characteristics and will work differently with your Class-E Tesla Coil. Find a CD which performs best and use that one for your demonstrations.

## **Conclusion**

We sincerely hope that you have enjoyed the construction of this Eastern Voltage Research Kit. As always, we have tried to write this instruction manual in the easiest, most “user friendly” format that is possible. As our customers, we value your opinions, comments, and additions that you would like to see in future publications. Please submit comments or ideas to:

Eastern Voltage Research, LLC

Technical Support  
support@easternvoltage.com

Thanks again from the people here at Eastern Voltage Research.

## **Terms and Conditions of Sale**

Before opening or assembling your kit, please read and review the latest Terms and Conditions of Sale on our website at the following link:

<http://www.easternvoltage.com/terms.html>

**Military Dash Number Identification (M39014/01-xxxx) – Ceramic Capacitors**

Failure Rate Level (%/1,000 Hours)				Capacitance (pF)	Capacitance Tolerance ±Percent	WVDC
1.0 (M)	0.1 (P)	0.01 (R)	0.001 (S)			
<b>CKR05 (BX)</b>						
1201	1241	1281	1321	10	10	200
1202	1242	1282	1322	10	20	200
1203	1243	1283	1323	12	10	200
1204	1244	1284	1324	15	10	200
1205	1245	1285	1325	15	20	200
1206	1246	1286	1326	18	10	200
1207	1247	1287	1327	22	10	200
1208	1248	1288	1328	22	20	200
1209	1249	1289	1329	27	10	200
1210	1250	1290	1330	33	10	200
1211	1251	1291	1331	33	20	200
1212	1252	1292	1332	39	10	200
1213	1253	1293	1333	47	10	200
1214	1254	1294	1334	47	20	200
1215	1255	1295	1335	56	10	200
1216	1256	1296	1336	68	10	200
1217	1257	1297	1337	68	20	200
1218	1258	1298	1338	82	10	200
1219	1259	1299	1339	100	10	200
1220	1260	1300	1340	100	20	200
1221	1261	1301	1341	120	10	200
1222	1262	1302	1342	150	10	200
1223	1263	1303	1343	150	20	200
1224	1264	1304	1344	180	10	200
1225	1265	1305	1345	220	10	200
1226	1266	1306	1346	220	20	200
1227	1267	1307	1347	270	10	200
1228	1268	1308	1348	330	10	200
1229	1269	1309	1349	330	20	200
1230	1270	1310	1350	390	10	200
1231	1271	1311	1351	470	10	200
1232	1272	1312	1352	470	20	200
1233	1273	1313	1353	560	10	200
1234	1274	1314	1354	680	10	200
1235	1275	1315	1355	680	20	200
1236	1276	1316	1356	820	10	200
1237	1277	1317	1357	1,000	10	200
1238	1278	1318	1358	1,000	20	200
1239	1279	1319	1359	1,200	10	100
1240	1280	1320	1360	1,500	10	100
1441	1481	1521	1561	1,500	20	100
1442	1482	1522	1562	1,800	10	100
1443	1483	1523	1563	2,200	10	100
1444	1484	1524	1564	2,200	20	100
1445	1485	1525	1565	2,700	10	100
1446	1486	1526	1566	3,300	10	100
1447	1487	1527	1567	3,300	20	100
1448	1488	1528	1568	3,900	10	100
1449	1489	1529	1569	4,700	10	100
1450	1490	1530	1570	4,700	20	100
1451	1491	1531	1571	5,600	10	100
1452	1492	1532	1572	6,800	10	100
1453	1493	1533	1573	6,800	20	100
1454	1494	1534	1574	8,200	10	100
1455	1495	1535	1575	10,000	10	100
1456	1496	1536	1576	10,000	20	100
1457	1497	1537	1577	12,000	10	50
1458	1498	1538	1578	15,000	10	50
1459	1499	1539	1579	15,000	20	50
1460	1500	1540	1580	18,000	10	50
1461	1501	1541	1581	22,000	10	50
1462	1502	1542	1582	22,000	20	50
1463	1503	1543	1583	27,000	10	50
1464	1504	1544	1584	33,000	10	50
1465	1505	1545	1585	33,000	20	50
1466	1506	1546	1586	39,000	10	50
1467	1507	1547	1587	47,000	10	50
1468	1508	1548	1588	47,000	20	50
1469	1509	1549	1589	56,000	10	50
1470	1510	1550	1590	68,000	10	50
1471	1511	1551	1591	68,000	20	50
1472	1512	1552	1592	82,000	10	50
1473	1513	1553	1593	100,000	10	50
1474	1514	1554	1594	100,000	20	50

**Military Dash Number Identification (M39014/02-xxxx) – Ceramic Capacitors**

Failure Rate Level (%/1,000 Hours)				Capacitance (pF)	Capacitance Tolerance ±Percent	WVDC
1.0 (M)	0.1 (P)	0.01 (R)	0.001 (S)			
<b>CKR06 (BX)</b>						
1201	1241	1281	1321	1200	10	200
1202	1242	1282	1322	1500	10	200
1203	1243	1283	1323	1500	20	200
1204	1244	1284	1324	1800	10	200
1206	1246	1286	1326	2200	10	200
1207	1247	1287	1327	2200	20	200
1208	1248	1288	1328	2700	10	200
1209	1249	1289	1329	3300	10	200
1210	1250	1290	1330	3300	20	200
1211	1251	1291	1331	3900	10	200
1212	1252	1292	1332	4700	10	200
1213	1253	1293	1333	4700	20	200
1214	1254	1294	1334	5600	10	200
1215	1255	1295	1335	6800	10	200
1216	1256	1296	1336	6800	20	200
1217	1257	1297	1337	8200	10	200
1218	1258	1298	1338	10,000	10	200
1219	1259	1299	1339	10,000	20	200
1231	1271	1311	1351	12,000	10	100
1220	1260	1300	1340	15,000	10	100
1221	1261	1301	1341	18,000	10	100
1222	1262	1302	1342	22,000	10	100
1232	1272	1312	1352	27,000	10	100
1223	1263	1303	1343	33,000	10	100
1224	1264	1304	1344	39,000	10	100
1225	1265	1305	1345	47,000	10	100
1226	1266	1306	1346	56,000	10	100
1227	1267	1307	1347	68,000	10	100
1229	1269	1309	1349	82,000	10	100
1230	1270	1310	1350	100,000	10	100
1233	1273	1313	1353	120,000	10	50
1234	1274	1314	1354	150,000	10	50
1235	1275	1315	1355	180,000	10	50
1236	1276	1316	1356	220,000	10	50
1237	1277	1317	1357	270,000	10	50
1238	1278	1318	1358	330,000	10	50
1239	1279	1319	1359	390,000	10	50
1240	1280	1320	1360	470,000	10	50
1404	1408	1412	1416	560,000	10	50
1405	1409	1413	1417	680,000	10	50
1406	1410	1414	1418	820,000	10	50
1407	1411	1415	1419	1,000,000	10	50